



# Solvent Safety Bottle Caps



A HALMA COMPANY

## Index

- Page 4 Q-SERIES BOTTLE CAPS**  
 ¼"-28 UNF ports with optional on-off valves. A screw-in check valve and filter is available for a completely closed solvent supply or waste system.
- Page 6 BARBED ADAPTORS**  
 Thread to barb adaptors to connect softwall tubing to ¼"-28 UNF ports.
- Page 7 SOFTWALL TUBING**  
 Chemically-resistant softwall Silicone Select™ and C-Flex® tubing for demanding applications. Ideal for use with barbed adaptors to connect into Q and T-series caps.
- Page 8 T-SERIES BOTTLE CAPS**  
 Luer ports combined with straight-through tubing connections, plus optional check valve and filter for a completely closed system.
- Page 10 T-SERIES LUER ADAPTORS**  
 A range of Luer accessories for quick and easy connection of different tubing types and sizes to T-series caps.
- Page 10 ACTIVATED CARBON VAPOR TRAP**  
 A solvent vapor trap with Luer connection for use with T-series caps in both solvent supply or waste collection applications.
- Page 11 OMNI-LOK™ INVERTED CONE FITTINGS**  
 Removable and reusable inverted cone fitting system for quick and convenient low-pressure connections, using semi-rigid tubing e.g. PTFE.
- Page 11 SEMI-RIGID PTFE TUBING**  
 Chemically inert PTFE tubing.
- Page 12 FILTERS AND BUBBLERS**  
 Bottom-of-bottle filters and spargers (bubblers) for simple, effective solvent filtration.
- Page 12 BUBBLE TRAP**  
 Effective in-line removal of bubbles.
- Page 13 PRESSURE-RATED GLASS BOTTLES**  
 Pressure-rated clear glass bottles.
- Page 13 S40 THREAD ADAPTOR**  
 Converts S40 bottle threads to accept T and Q-series GL45 bottle caps.
- Page 14 TECHNICAL DATA**

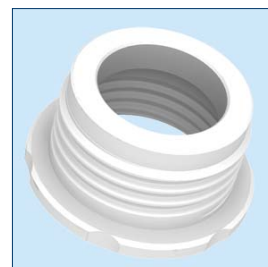
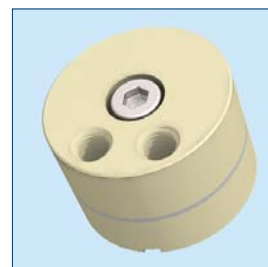

### Plastics

ETFE = ethylene tetrafluoroethylene  
 PTFE = polytetrafluoroethylene  
 PEEK™ = polyetheretherketone  
 PP = polypropylene  
 PC = polycarbonate  
 PCTFE = polychlorotrifluoroethylene

### Trademarks

PEEK™ is a registered trademark of Victrex plc.  
 Omnifit®, Omni-Lok™ are trademarks of Diba Industries Ltd.





# Bottle Caps Selection Guide

In the table below:

1. Choose the connection type you require for your fluid lines;
2. Locate the thread type of the bottle you wish to connect to;
3. Turn to the pages indicated to see full details and ordering information for each system.

| Bottle Thread    | Fluid Line Connection                                   |   |
|------------------|---|---|
|                  | Threaded fittings + optional on-off valves on each line | Straight-through tubes                            |
| GL32             | 00932Q (Page 4)   | 00932T (Page 8)                                   |
| GL45             | 00945Q (Page 4)   | 00945T (Page 8)                                   |
| 38-430 (Glass)   | 00938Q (Page 4)   | 00938T (Page 8)                                   |
| 38-430 (Plastic) | 00938PQ (Page 4)  | 00938PT (Page 8)                                  |
| S40              | 00945Q (Page 4)<br>+ S40 thread adaptor (Page 13)       | 00945T (Page 8)<br>+ S40 thread adaptor (Page 13) |

## Guide to thread types:

| GL32  | GL45  | 38-430   | S40   |
|---|---|--|---|
| <p>1.26"<br/>[32.0mm]</p>  | <p>1.77"<br/>[45.0mm]</p>  | <p>1.50"<br/>[38.0mm]</p>  | <p>1.57"<br/>[40.0mm]</p>  |



## Q-SERIES BOTTLE CAPS

### 1/4"-28 UNF ports with optional on-off valves

- Accept standard male 1/4"-28 UNF fittings
- Anti-twist design
- Optional on-off valves to control individual fluid lines

The Omnifit® Q-series provides a versatile range of caps with the security of threaded fitting nuts to ensure a leak-free, vapor-tight seal - ideal for repeated connect / disconnect.

### Anti-twist design

The anti-twist design allows the PTFE body to spin freely within the outer blue cap. This means no more twisted tubes when the cap is fitted or removed and no need to disconnect fluid lines before unscrewing the cap. See more details in Technical Data (page 14).

### Tubing connections

Q-series caps offer a secure way to connect tubing using 1/4"-28 UNF fitting nuts. Each port has a robust stainless steel thread insert to enable repeated connect/disconnect.

- Semi-rigid tubing can be connected using standard 1/4"-28 UNF threaded fittings. We recommend Omni-Lok™ fittings (see p11).
- Fluid lines can be color-coded for easy identification using colored fitting nuts.
- Softwall tube, such as silicone, can be connected using Omnifit® PEEK™ thread to barb adaptors (see p6).
- A length of 1/8" OD PTFE tubing is supplied fitted inside the cap and extending into the bottle. This can be cut to fit, or easily replaced if a longer length is required.
- Non-valved caps have Ø1.8mm (0.07") through-holes enable 1/16" OD semi-rigid tubing to be passed straight through into the bottle. Tube can be secured at the required height using an Omni-Lok™ inverted cone fitting.

### On-off valves

On-off valves enable easy control of liquid flow into and out of the bottle, as each fluid line can be switched on or off independently. Changing bottles is easy - simply close off the fluid lines and switch the cap onto a new reservoir without leaks. Caps without valves have a compact design ideal when head space is limited.

### Materials

The solid PTFE inner body provides the highest chemical inertness. The PTFE creates a reliable seal to the glass bottle with no need for extra seals or O-rings. In normal use, the outer cap is not wetted.

| Component   | Material        |
|---|-----------------|
| Outer cap   | Glass-filled PP |
| Body  | PTFE            |
| Valve internal rotor<br>(for caps with on-off valves) | PCTFE           |

### Pressure & temperature ratings

Q-series caps (except 00938PQ\*) can be used under vacuum or positive pressure. All caps are rated for continuous use at 50°C and can be autoclaved.

| Type                       | Vacuum  | +ve pressure |
|----------------------------|---------|--------------|
| Q-series (except 00938PQ*) | -10 psi | 20 psi       |

CAUTION! Use only vacuum or pressure-rated bottles

## SPECIFICATIONS



### Dimensions

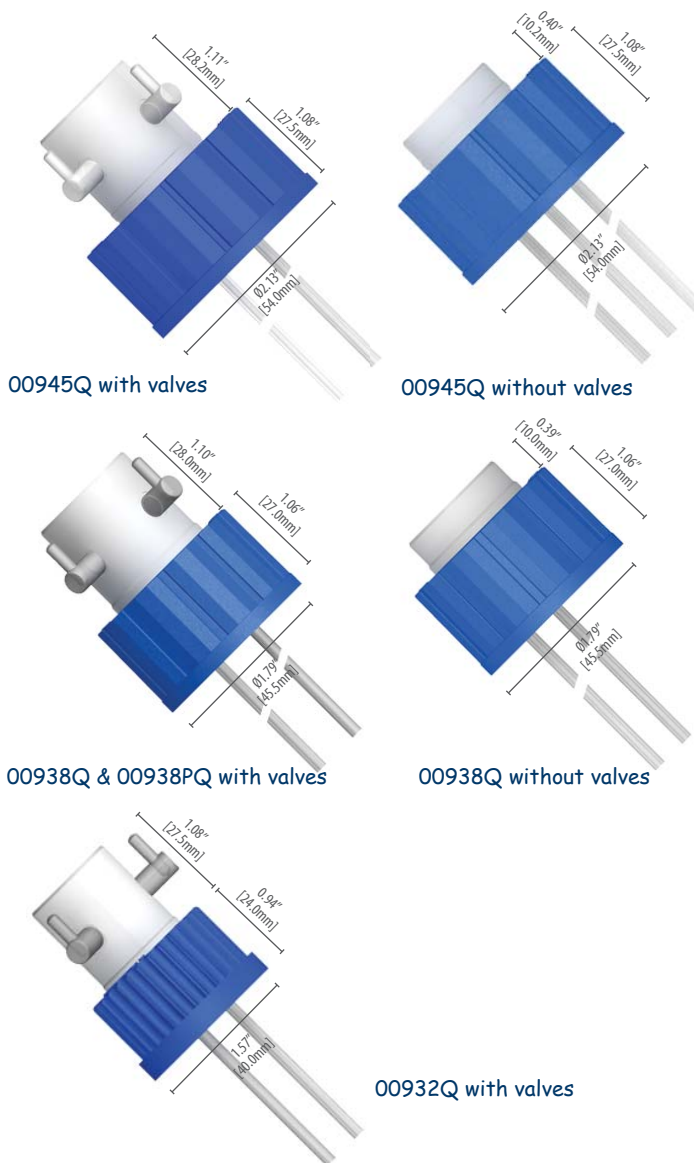

Ordering information:

Q-series caps with on-off valves

GL45 THREAD

| PART NUMBER | BOTTLE THREAD | PORTS      | ON-OFF VALVES | QTY |
|-------------|---------------|------------|---------------|-----|
| 00945Q-2V   | GL45          | 2 x 1/4"28 | YES           | ea  |
| 00945Q-3V   | GL45          | 3 x 1/4"28 | YES           | ea  |
| 00945Q-4V   | GL45          | 4 x 1/4"28 | YES           | ea  |

38-430 (GL38) GLASS BOTTLE THREAD

|           |        |            |     |    |
|-----------|--------|------------|-----|----|
| 00938Q-2V | 38-430 | 2 x 1/4"28 | YES | ea |
| 00938Q-3V | 38-430 | 3 x 1/4"28 | YES | ea |
| 00938Q-4V | 38-430 | 4 x 1/4"28 | YES | ea |

38-430 (GL38) PLASTIC BOTTLE THREAD

|            |        |            |     |    |
|------------|--------|------------|-----|----|
| 00938PQ-2V | 38-430 | 2 x 1/4"28 | YES | ea |
| 00938PQ-3V | 38-430 | 3 x 1/4"28 | YES | ea |

GL32 THREAD

|           |      |            |     |    |
|-----------|------|------------|-----|----|
| 00932Q-3V | GL32 | 3 x 1/4"28 | YES | ea |
|-----------|------|------------|-----|----|



**00945Q-2V**  
GL45 cap, 2 port, on-off valves

**00945Q-3V**  
GL45 cap, 3 port, on-off valves

**00945Q-4V**  
GL45 cap, 4 port, on-off valves



**00938Q-2V**  
38-430 cap, 2 port, on-off valves for glass bottles

**00938Q-3V**  
38-430 cap, 3 port, on-off valves for glass bottles

**00938Q-4V**  
38-430 cap, 4 port, on-off valves for glass bottles



**00938PQ-2V**  
38-430 cap, 2 port, on-off valves for plastic bottles

**00938PQ-3V**  
38-430 cap, 3 port, on-off valves for plastic bottles

**00932Q-3V**  
GL32 cap, 3 port, on-off valves

\*00938PQ caps are designed to fit plastic bottles which are unsuitable for vacuum or pressurized applications. Therefore, 00938PQ caps are not pressure-rated.

Q-series caps without on-off valves

GL45 THREAD

| PART NUMBER | BOTTLE THREAD | PORTS      | ON-OFF VALVES | QTY |
|-------------|---------------|------------|---------------|-----|
| 00945Q-2    | GL45          | 2 x 1/4"28 | NO            | ea  |
| 00945Q-3    | GL45          | 3 x 1/4"28 | NO            | ea  |
| 00945Q-4    | GL45          | 4 x 1/4"28 | NO            | ea  |

38-430 (GL38) GLASS BOTTLE THREAD

|          |        |            |    |    |
|----------|--------|------------|----|----|
| 00938Q-2 | 38-430 | 2 x 1/4"28 | NO | ea |
| 00938Q-3 | 38-430 | 3 x 1/4"28 | NO | ea |
| 00938Q-4 | 38-430 | 4 x 1/4"28 | NO | ea |



**00945Q-2**  
GL45 cap, 2 port

**00945Q-3**  
GL45 cap, 3 port

**00945Q-4**  
GL45 cap, 4 port



**00938Q-2**  
38-430 cap, 2 port for glass bottles

**00938Q-3**  
38-430 cap, 3 port for glass bottles

**00938Q-4**  
38-430 cap, 4 port for glass bottles

Closed systems

To fully close a solvent system, a screw-in check valve and filter can be used in any spare port. These units allow pressure to be equalized while preventing particulate contamination.

The inlet version (Part# 009VF) is recommended for solvent supply. Vapor is completely contained within the bottle by the one-way check valve. When liquid is withdrawn, air is allowed into the bottle, equalizing pressure.

The outlet version (Part# 009VF-W) allows air to escape from the bottle as liquid is pumped in and is recommended for solvent waste collection. NOTE: when using the outlet check valve, appropriate precautions for vapor containment should be made, for example placing in a fume hood.

SCREW-IN CHECK VALVE AND FILTER

| PART NUMBER | DESCRIPTION                                | QTY |
|-------------|--|-----|
| 009VF       | Inlet check valve & filter, 1/4"28 thread  | ea  |
| 009VF-W     | Outlet check valve & filter, 1/4"28 thread | ea  |

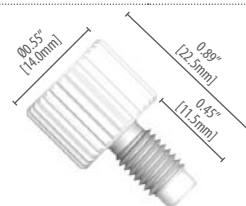

**009VF & 009VF-W**  
Inlet or outlet check valve & filter, 1/4"28 thread

**BARBED ADAPTORS**

**Thread to barb adaptors to connect softwall tubing to 1/4"-28 UNF ports**

Omnifit® barbed adaptors are designed for use with softwall tubing. Machined from chemically resistant PEEK™ they have a superior barb with a crisp edge that retains soft wall tubing more securely than molded adaptors.

These male 1/4"-28 UNF to barb adaptors can be used to connect softwall tubing into female 1/4"-28 UNF ports on any Q-series bottle cap. The male thread screws into the port and tubing can then be pushed over the barb.

A tight, leak-free connection can be ensured by matching the ID of your tubing to the barb size of the adaptor. If there is not an exact match, always choose the barb size that is just larger than your tubing ID.

**SPECIFICATIONS**

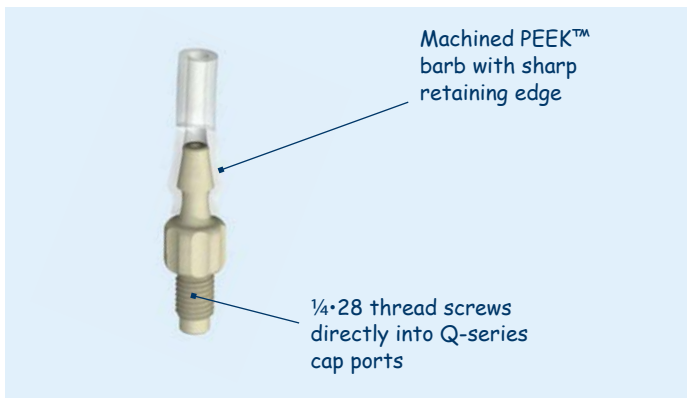

**MALE 1/4"-28 UNF TO BARB ADAPTOR**

| PART NUMBER | MATERIAL | COLOR   | THREAD | BARB SIZE/TUBE ID | QTY |
|-------------|----------|---------|--------|-------------------|-----|
| 001070      | PEEK™    | Natural | 1/4•28 | 0.039" (1.0mm)    | ea  |
| 001064      | PEEK™    | Natural | 1/4•28 | 0.059" (1.5mm)    | ea  |
| 001065      | PEEK™    | Natural | 1/4•28 | 0.079" (2.0mm)    | ea  |
| 001066      | PEEK™    | Natural | 1/4•28 | 0.098" (2.5mm)    | ea  |
| 001071      | PEEK™    | Natural | 1/4•28 | 0.118" (3.0mm)    | ea  |
| 001069      | PEEK™    | Natural | 1/4•28 | 1/8" (3.2mm)      | ea  |
| 001072      | PEEK™    | Natural | 1/4•28 | 0.157" (4.0mm)    | ea  |
| 001073      | PEEK™    | Natural | 1/4•28 | 0.236" (6.0mm)    | ea  |
| 001074      | PEEK™    | Natural | 1/4•28 | 0.315" (8.0mm)    | ea  |

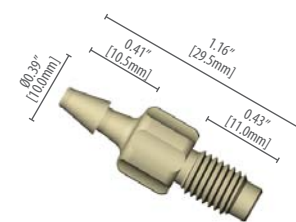

**001071**  
1/4•28 to 0.118" (3.0 mm) barb

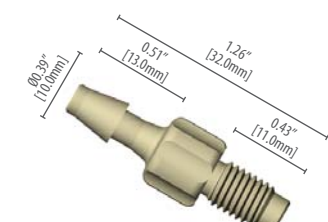

**001069**  
1/4•28 to 1/8" (3.2 mm) barb

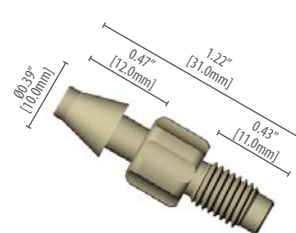

**001072**  
1/4•28 to 0.157" (4.0 mm) barb

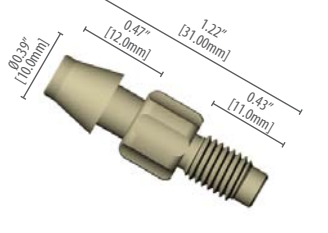

**001073**  
1/4•28 to 0.236" (6.0 mm) barb

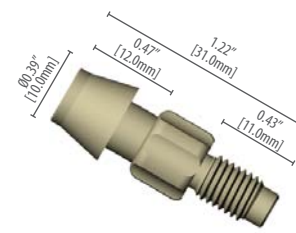

**001074**  
1/4•28 to 0.315" (8.0 mm) barb

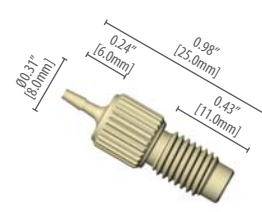

**001070**  
1/4•28 to 0.039" (1.0 mm) barb

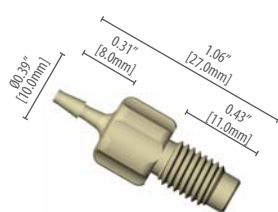

**001064**  
1/4•28 to 0.059" (1.5 mm) barb

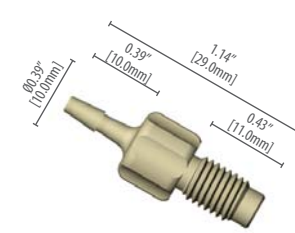

**001065**  
1/4•28 to 0.079" (2.0 mm) barb

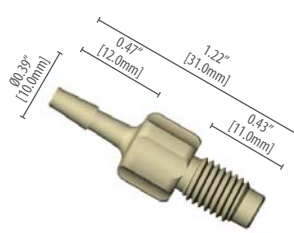

**001066**  
1/4•28 to 0.098" (2.5 mm) barb

**TECH TIP:**

**Connecting softwall tube?**

Always screw the adaptor into the threaded port before pushing the softwall tubing over the barb. This ensures a secure, leak-free seal and prevents tubing getting twisted.

## SOFTWALL TUBING

Chemically resistant softwall tubing for demanding applications - ideal for use with barbed adaptors

- Softwall Silicone Select™
- Bio-Chem (C-Flex®) tubing

### Softwall Silicone Select™

Silicone Select™ tubing is platinum cured silicone tubing designed for high-purity medical grade applications. It complies with USP XXII, Class VI, FDA and USDA standards and is FDA master file listed.

| SILICONE SELECT™ TUBING |                 |                 |        |     |
|-------------------------|-----------------|-----------------|--------|-----|
| PART NUMBER             | OD              | ID              | LENGTH | QTY |
| 10025-10S               | 0.093" (2.36mm) | 0.010" (0.25mm) | 50ft   | ea  |
| 10025-23S               | 0.093" (2.36mm) | 0.023" (0.58mm) | 50ft   | ea  |
| 10025-50S               | 0.134" (3.40mm) | 0.050" (1.27mm) | 50ft   | ea  |
| 10025-01S               | 3/32" (2.38mm)  | 1/32" (0.79mm)  | 50ft   | ea  |
| 10025-02S               | 1/8" (3.17mm)   | 1/16" (1.59mm)  | 50ft   | ea  |
| 10025-03S               | 3/16" (4.76mm)  | 1/16" (1.59mm)  | 50ft   | ea  |
| 10025-04S               | 1/4" (6.35mm)   | 3/16" (4.76mm)  | 50ft   | ea  |
| 10025-05S               | 1/4" (6.35mm)   | 1/8" (3.17mm)   | 50ft   | ea  |
| 10025-06S               | 3/8" (9.52mm)   | 1/4" (6.35mm)   | 50ft   | ea  |
| 10025-07S               | 7/16" (11.1mm)  | 5/16" (7.94mm)  | 50ft   | ea  |

## Softwall Bio-Chem (C-Flex®) Tubing

Bio-Chem (C-Flex®) tubing is designed for high-purity medical grade applications, complies with USP XXII, Class VI, FDA and USDA standards and is FDA master file listed. This tubing is recommended for applications where gas permeability is an issue.

| BIO-CHEM (C-FLEX®) TUBING |                 |                 |        |     |
|---------------------------|-----------------|-----------------|--------|-----|
| PART NUMBER               | OD              | ID              | LENGTH | QTY |
| 10025-23B                 | 0.093" (2.36mm) | 0.023" (0.58mm) | 50ft   | ea  |
| 10025-01B                 | 3/32" (2.38mm)  | 1/32" (0.79mm)  | 50ft   | ea  |
| 10025-02B                 | 1/8" (3.17mm)   | 1/16" (1.59mm)  | 50ft   | ea  |
| 10025-03B                 | 3/16" (4.76mm)  | 1/16" (1.59mm)  | 50ft   | ea  |
| 10025-05B                 | 1/4" (6.35mm)   | 1/8" (3.17mm)   | 50ft   | ea  |
| 10025-06B                 | 3/8" (9.52mm)   | 1/4" (6.35mm)   | 50ft   | ea  |
| 10025-07B                 | 7/16" (11.1mm)  | 5/16" (7.94mm)  | 50ft   | ea  |

| TUBING CUTTER |                   |     |
|---------------|-------------------|-----|
| PART NUMBER   | DESCRIPTION       | QTY |
| 003062        | Tubing cutter     | ea  |
| 003063        | Replacement blade | ea  |

## Recommended barbed adaptor / softwall tube combinations

The fit of softwall tubing to a barb connector or adaptor depends on several factors, including the tube materials and flexibility. There is no fixed pairing of tube ID and barb size. Tubing of a specific ID may still fit over a barb of larger size than the quoted ID of the tubing, if for example the tube has a thin wall and is particularly stretchy. However, we are able to recommend certain part numbers from our range of barbed adaptors to fit specific tubing supplied by Diba Industries. Tubing from other manufacturers must be tested by the customer to find the barbed adaptor that gives the best fit.

| Barbed Adaptor Part # | DIBA INDUSTRIES SOFTWALL TUBING SIZE AND TYPE |     |     |     |     |     |     |     |     |     |     |     |     |     |     |     |     |
|-----------------------|---|-----|-----|-----|-----|-----|-----|-----|-----|-----|-----|-----|-----|-----|-----|-----|-----|
|                       | 10S   | 23S | 23B | 50S | 01S | 01B | 02S | 02B | 03S | 03B | 04S | 05S | 05B | 06S | 06B | 07S | 07B |
| 001070                | ■   | ■   | ■   | ■   | ■   | ■   |     |     |     |     |     |     |     |     |     |     |     |
| 001064                |   |     |     | ■   | ■   | ■   | ■   | ■   | ■   | ■   |     |     |     |     |     |     |     |
| 001065                |   |     |     | ■   |     |     | ■   | ■   | ■   | ■   |     |     |     |     |     |     |     |
| 001066                |   |     |     | ■   |     |     | ■   | ■   | ■   | ■   |     |     |     |     |     |     |     |
| 001071                |   |     |     |     |     |     | ■   | ■   | ■   | ■   |     | ■   | ■   |     |     |     |     |
| 001069                |   |     |     |     |     |     |     |     |     |     | ■   | ■   | ■   |     |     |     |     |
| 001072                |   |     |     |     |     |     |     |     |     |     | ■   | ■   | ■   | ■   |     |     |     |
| 001073                |   |     |     |     |     |     |     |     |     |     |     | ■   | ■   | ■   | ■   |     |     |
| 001074                |   |     |     |     |     |     |     |     |     |     |     |     |     | ■   | ■   | ■   | ■   |



## T-SERIES BOTTLE CAPS

### Luer ports combined with straight-through tubing connections plus optional check valve and filter

- Straight-through connection for 1/8" OD semi-rigid tube e.g. PTFE, ETFE, FEP.
- Other sizes and types of tube can be connected using Luer adaptors.
- Optional check valve and filter allows pressure equalization and prevents particulate contamination
- Ideal for vacuum applications

The Omnifit® T-series is a very easy to use and versatile range of caps that require no additional fittings to connect 1/8" OD semi-rigid tubing. Tubing pushes straight through the port creating a liquid and vapor-tight seal.

### Anti-twist design

The anti-twist design allows the PTFE body to spin freely within the outer blue cap. This means no more twisted tubes when the cap is fitted or removed and no need to disconnect fluid lines before unscrewing the cap. See more details in Technical Data (page 14).

### Tubing connections

- 1/8" OD semi-rigid tubing pushes straight through the port creating a liquid and vapor-tight seal.
- 1/16" OD semi-rigid tubing can be connected using a Luer adaptor part #009LA (page 10).
- Softwall tubing such as peristaltic pump tubing can be connected using one of a range of Luer to barb adaptors available separately (see page 10).
- Luer ports also mean you can easily and securely remove liquid using a syringe - no septum to pierce, just fit the male luer of the syringe into a port.

### Integral check valve and filter

The optional check valve and filter offers many advantages for the laboratory user. The one-way check valve:

- Allows pressure equalization - as liquid is drawn out of the bottle under vacuum, air is allowed in preventing dangerous negative pressurization of the bottle.
- Prevents vapor escape - helping protect the laboratory environment and personnel from dangerous chemical vapor.
- Helps conserve valuable contents from evaporation - minimizing the loss of valuable chemicals and risk of concentrations and mixtures changing ratio.
- The air inlet is covered by a 10µm filter to prevent particulate contamination.

### Materials

The solid PTFE inner body provides the highest chemical inertness. The PTFE creates a reliable seal to the glass bottle with no need for extra seals or O-rings. In normal use, the outer cap is not wetted.

| Component          | Material        |
|--------------------|-----------------|
| Outer cap          | Glass-filled PP |
| Inner sealing face | PTFE            |
| Check valve        | Fluorocarbon    |
| Filter             | 10µm PTFE       |

## SPECIFICATIONS

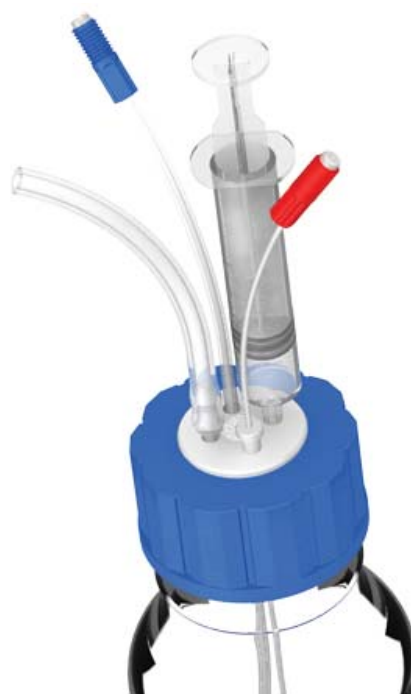

### Pressure & temperature ratings

T-series caps are ideal for use in vacuum applications. T-series caps without an integral check valve and filter can also be used in positive pressure applications but only when 1/8" OD through tubes are used. T-series caps with male Luers fitted are not recommended for positive pressure applications. All caps are rated for continuous use at 50°C and can be autoclaved.

| Type  | Vacuum  | +Ve pressure    |
|---|---------|-----------------|
| T-series without valve*; with 1/8" OD through tubes | -10 psi | 20 psi          |
| T-series without valve*; with male Luers            | -10 psi | Not recommended |
| T-series with valve*                                | -10 psi | Not recommended |

CAUTION! Use only vacuum or pressure-rated bottles

### Dimensions

00945T

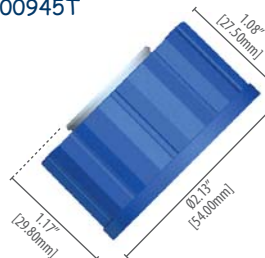

00938T & 00938PT

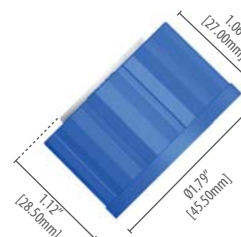

00932T

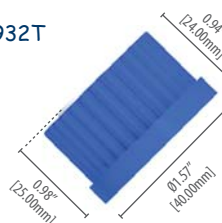

Ordering information

T-series caps with integral check valve and filter

| GL45 THREAD                         |               |          |                      |     |
|-------------------------------------|---------------|----------|----------------------|-----|
| PART NUMBER                         | BOTTLE THREAD | PORTS    | CHECK VALVE & FILTER | QTY |
| 00945T-2F                           | GL45          | 2 x Luer | YES                  | ea  |
| 00945T-3F                           | GL45          | 3 x Luer | YES                  | ea  |
| 00945T-4F                           | GL45          | 4 x Luer | YES                  | ea  |
| 38-430 (GL38) GLASS BOTTLE THREAD   |               |          |                      |     |
| 00938T-2F                           | 38-430        | 2 x Luer | YES                  | ea  |
| 00938T-3F                           | 38-430        | 3 x Luer | YES                  | ea  |
| 00938T-4F                           | 38-430        | 4 x Luer | YES                  | ea  |
| 38-430 (GL38) PLASTIC BOTTLE THREAD |               |          |                      |     |
| 00938PT-2F                          | 38-430        | 2 x Luer | YES                  | ea  |

T-series caps without integral check valve and filter

| GL32 THREAD                         |               |          |                      |     |
|-------------------------------------|---------------|----------|----------------------|-----|
| PART NUMBER                         | BOTTLE THREAD | PORTS    | CHECK VALVE & FILTER | QTY |
| 00932T-2                            | GL32          | 2 x Luer | NO                   | ea  |
| GL45 THREAD                         |               |          |                      |     |
| 00945T-2                            | GL45          | 2 x Luer | NO                   | ea  |
| 00945T-3                            | GL45          | 3 x Luer | NO                   | ea  |
| 00945T-4                            | GL45          | 4 x Luer | NO                   | ea  |
| 38-430 (GL38) GLASS BOTTLE THREAD   |               |          |                      |     |
| 00938T-2                            | 38-430        | 2 x Luer | NO                   | ea  |
| 00938T-3                            | 38-430        | 3 x Luer | NO                   | ea  |
| 00938T-4                            | 38-430        | 4 x Luer | NO                   | ea  |
| 38-430 (GL38) PLASTIC BOTTLE THREAD |               |          |                      |     |
| 00938PT-2                           | 38-430        | 2 x Luer | NO                   | ea  |



**00945T-2F**  
GL45, 2 port, check valve/filter



**00945T-3F**  
GL45, 3 port, check valve/filter



**00945T-4F**  
GL45, 4 port, check valve/filter



**00945T-2**  
GL45 cap, 2 port



**00945T-3**  
GL45 cap, 3 port



**00945T-4**  
GL45 cap, 4 port



**00938T-2F**  
38-430, 2 port, check valve/filter for glass bottles



**00938T-3F**  
38-430, 3 port, check valve/filter for glass bottles



**00938T-4F**  
38-430, 4 port, check valve/filter for glass bottles



**00938T-2**  
38-430, 2 port for glass bottles



**00938T-3**  
38-430, 3 port for glass bottles



**00938T-4**  
38-430, 4 port for glass bottles



**00938PT-2F**  
38-430, 2 port, check valve/filter for plastic bottles



**00938PT-2**  
38-430, 2 port for plastic bottles



**00932T-2**  
GL32 cap, 2 port

\* Except 00938PT caps. These caps are designed to fit plastic bottles which are unsuitable for vacuum or pressurized applications. Therefore, 00938PQ caps are not pressure-rated.

### T-SERIES LUER ADAPTORS

A range of Luer accessories for quick and easy connection of different tubing types and sizes to T-series caps

Simply connect the tube onto the appropriate adaptor and then push the male Luer into any T-series cap port. A Luer plug is also available to seal unused ports.

#### Ordering information

##### LUER ADAPTORS FOR SEMI-RIGID TUBING

| PART NUMBER | DESCRIPTION                                   | QTY |
|-------------|---|-----|
| 009LA2      | Adaptor to connect 1/16" OD semi-rigid tubing | 2pk |

##### LUER ADAPTORS FOR SOFT TUBING

|          |   |     |
|----------|---|-----|
| 009BA-16 | Barbed adaptor for 1/16" ID softwall tubing | 2pk |
| 009BA-32 | Barbed adaptor for 1/8" ID softwall tubing  | 2pk |
| 009BA-63 | Barbed adaptor for 1/4" ID softwall tubing  | 2pk |

##### LUER PLUG

|       |                                 |     |
|-------|---------------------------------|-----|
| 009LP | Luer plug to close unused ports | 2pk |
|-------|---------------------------------|-----|

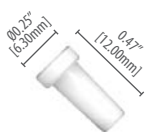

**009LA**  
Luer adaptor,  
1/16" OD tube

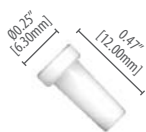

**009LP**  
Luer plug

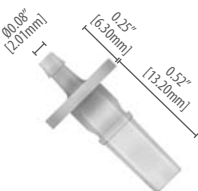

**009BA-16**  
Luer to barb adaptor,  
1/16" ID tube

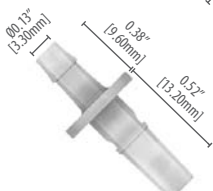

**009BA-32**  
Luer to barb adaptor,  
1/8" ID tube

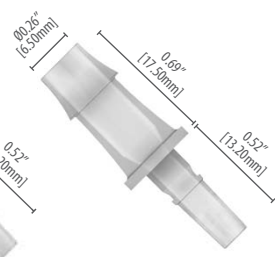

**009BA-63**  
Luer to barb adaptor,  
1/4" ID tube

#### Recommended barbed adaptor / tube combinations

The fit of softwall tubing to a barb connector or adaptor depends on several factors, so there is no fixed pairing of tube ID and barb size. However, we are able to recommend certain part numbers from our range of barbed adaptors to fit specific tubing supplied by Diba Industries. Tubing from other manufacturers must be tested by the customer to find the barbed adaptor that gives the best fit.

| Barbed Adaptor Part # | DIBA INDUSTRIES SOFTWALL TUBING SIZE AND TYPE |     |     |     |     |     |     |     |     |     |     |     |     |     |
|-----------------------|---|-----|-----|-----|-----|-----|-----|-----|-----|-----|-----|-----|-----|-----|
|                       | 50S   | 01S | 01B | 02S | 02B | 03S | 03B | 04S | 05S | 05B | 06S | 06B | 07S | 07B |
| 009BA-16              |   |     |     |     |     |     |     |     |     |     |     |     |     |     |
| 009BA-32              |   |     |     |     |     |     |     |     |     |     |     |     |     |     |
| 009BA-63              |   |     |     |     |     |     |     |     |     |     |     |     | *   | *   |

\* This tube / barb combination is only suitable for very low pressure systems, due to the very low interference fit between the tube and the barb.

### ACTIVATED CARBON VAPOR TRAP

A solvent vapor trap with Luer connection for use with T-series caps in solvent supply or waste collection applications

- Simple, male Luer connection fits all T-series bottle caps
- Controls solvent vapor escape from reservoirs
- Traps solvent vapor and equalizes pressure when solvent is pumped into the bottle
- Enables T-series caps to be used for waste collection

This simple to use solvent vapor trap push-fits into a spare Luer port on any T-series cap. For waste collection, as liquid is pumped into the bottle, vapor can pass out through the filter port, thereby equalizing pressure. Dangerous solvent vapors are absorbed by the activated carbon contained in the unit. It is important that any other unused ports are sealed using a Luer plug (part # 009LP) to prevent solvent vapor escaping directly into the environment.

Note: The push-fit nature of the vapor trap and Luer plugs mean that only low positive pressure should be applied to prevent Luer connections being loosened.

The trap can also be used for solvent (mobile phase) reservoir bottles. If a T-series bottle cap without check valve and filter is selected, the vapor trap can be used in any spare port to ensure that vapor escape into the environment, for example, as a result of temperature changes, is controlled.

#### SPECIFICATIONS

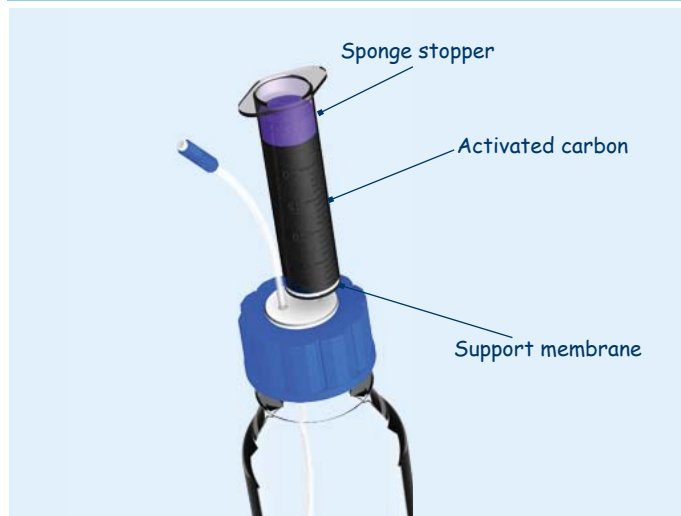

#### Usage

The unit contains approx. 25ml charcoal. The frequency of exchange of the unit depends on local conditions and type of solvent used. Users must determine the saturation rate of the activated carbon for their own specific solvents, concentrations and flow rates and change the unit accordingly to ensure that vapor break-through is minimized. As a guide, the capacity of the unit for methanol is approximately 1.6g and for other solvents approx. 2.5g.

#### Ordering information

##### ACTIVATED CARBON VAPOR TRAP

| PART NUMBER | DESCRIPTION                                   | QTY |
|-------------|---|-----|
| 009CF-T     | Activated carbon vapor trap for T-series caps | ea  |

## OMNI-LOK™ INVERTED CONE FITTINGS

Removable and reusable system for quick and convenient low-pressure connections

- Pressure rated up to 250psi (17 bar)
- For 1/16", 1/8" and metric sizes 2.0, 2.5 or 3.0mm OD semi-rigid PTFE tubing
- For flat-bottom 1/4"-28 UNF ports

### SPECIFICATIONS

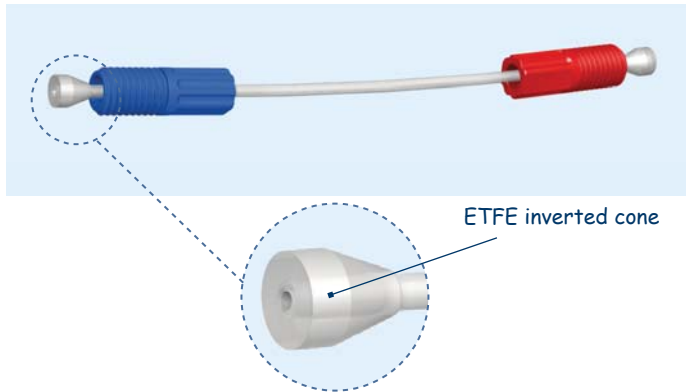

Omni-Lok™ inverted cone fittings provide a simple, easy to use low-pressure connection. Only the ETFE cone is in the fluid path.

No tools are required to assemble these flangeless fitting quickly and economically - just slip the fitting nut and the ETFE cone over the tubing and screw into the port. None of the parts are permanently attached to the tubing, so both fittings and inverted cones can easily be removed and re-used. A recess in the fitting houses the inverted cone, allowing maximum thread engagement with the port ensuring the system stays sealed up to 250psi (17 bar) pressure even in shallow PTFE ports.

The fitting nuts in robust, glass-filled polypropylene are available in a range of different colors for easy line identification. Nuts are also available in PEEK™ with standard and compact head designs (see the Omnifit® Fitting Systems Brochure for our full range).

### For 1/16" OD tubing

#### INVERTED CONES FOR 1/16" OD TUBING

| PART NUMBER | DESCRIPTION        | QTY  |
|-------------|--------------------|------|
| 008CZ16     | ETFE inverted cone | 10pk |

008CZ16 inverted cones can be used with all nuts listed below.

#### NUTS FOR 1/16" OD TUBING

| PART NUMBER  | MATERIAL | COLOR | THREAD | QTY  |
|--------------|----------|-------|--------|------|
| 008NC16-YC5U | PP       | Blue  | 1/4•28 | 10pk |
| 008NC16-YC5G | PP       | Green | 1/4•28 | 10pk |

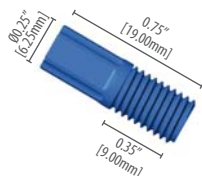

**008NC16-YC5U**  
Nut for 1/16" OD tubing 1/4•28, blue



**008CZ16**  
Omni-Lok™ inverted cone for 1/16" OD tubing

### For 1/8", 2.0, 2.5 and 3.0mm OD tubing

#### INVERTED CONES FOR 1/8", 2.0, 2.5 & 3.0MM OD TUBING

| PART NUMBER | MATERIAL | TO FIT TUBE OD | QTY  |
|-------------|----------|----------------|------|
| 008CZ19     | ETFE     | 1.8 - 2.0mm    | 10pk |
| 008CZ25     | ETFE     | 2.5mm          | 10pk |
| 008CZ30     | ETFE     | 3.0mm          | 10pk |
| 008CZ32     | ETFE     | 1/8" (3.2mm)   | 10pk |

#### NUTS FOR 1/8", 2.0, 2.5 & 3.0MM OD TUBING

| PART NUMBER  | MATERIAL | COLOR  | THREAD | QTY  |
|--------------|----------|--------|--------|------|
| 008NC32-YC5U | PP       | Blue   | 1/4•28 | 10pk |
| 008NC32-YC5G | PP       | Green  | 1/4•28 | 10pk |
| 008NC32-YC5N | PP       | Orange | 1/4•28 | 10pk |
| 008NC32-YC5R | PP       | Red    | 1/4•28 | 10pk |
| 008NC32-YC5Y | PP       | Yellow | 1/4•28 | 10pk |

The 008NC32 nuts can be used with all tube sizes and inverted cones listed above.

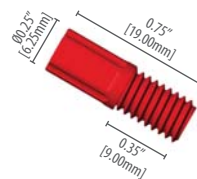

**008NC32-YC5R**  
Nut for 1/8" OD tubing, 1/4•28, red



**008CZ32**  
Omni-Lok™ inverted cone for 1/8" OD tubing

## SEMI-RIGID PTFE TUBING

Almost totally inert, PTFE tubing can be used with virtually all chemicals, solvents and corrosive materials, even at elevated temperatures. It can be sterilised in-line by steam, chemical methods or autoclaving. Recommended for use with Omni-Lok™ inverted cone fittings.

#### PTFE TUBING

| PART NUMBER    | OD            | ID             | LENGTH | QTY |
|----------------|---------------|----------------|--------|-----|
| 008T16-030-20  | 1.6mm (1/16") | 0.3mm (0.012") | 20m    | ea  |
| 008T16-030-200 | 1.6mm (1/16") | 0.3mm (0.012") | 200m   | ea  |
| 008T16-050-20  | 1.6mm (1/16") | 0.5mm (0.020") | 20m    | ea  |
| 008T16-050-200 | 1.6mm (1/16") | 0.5mm (0.020") | 200m   | ea  |
| 008T16-080-20  | 1.6mm (1/16") | 0.8mm (0.031") | 20m    | ea  |
| 008T16-080-200 | 1.6mm (1/16") | 0.8mm (0.031") | 200m   | ea  |
| 008T16-100-20  | 1.6mm (1/16") | 1.0mm (0.039") | 20m    | ea  |
| 008T16-100-200 | 1.6mm (1/16") | 1.0mm (0.039") | 200m   | ea  |
| 008T32-150-10  | 3.2mm (1/8")  | 1.5mm (0.059") | 10m    | ea  |
| 008T32-150-100 | 3.2mm (1/8")  | 1.5mm (0.059") | 100m   | ea  |

#### TECH TIP:

Need more connection options?

See the Omnifit® Fitting Systems Brochure for our full range of threaded fittings, connectors and adaptors.

## FILTERS AND BUBBLERS

### Bottom-of-bottle filters and spargers for simple, effective solvent filtration

- Push-fit onto 1/8" OD tube
- Inert, all-PTFE filter units with 10µm porosity filters
- PTFE or stainless steel bubblers

### Bottom-of-bottle filters

All-PTFE construction enables the filters to be used with the harshest chemicals. The filter units have slots in the body to enable virtually all liquid to be removed from the bottle, minimizing waste. 10µm porosity PTFE filters ensure even the smallest particulates are removed from the solvent supply.

### Filter spargers (bubblers)

PTFE or stainless steel elements are suitable for filtration or sparging applications.

### Materials

| Component | Body | Filter    |
|-----------|------|-----------|
| 009F-32   | PTFE | 10µm PTFE |
| 009F-45   | PTFE | 10µm PTFE |
| 009PFB    | PTFE | 3µm PTFE  |
| 009SFB    | PTFE | 10µm SS   |

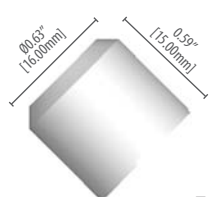

**009F-32**  
Filter for GL32 bottle,  
PTFE, 10µm

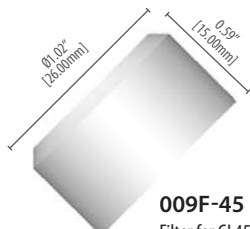

**009F-45**  
Filter for GL45 bottle,  
PTFE, 10µm

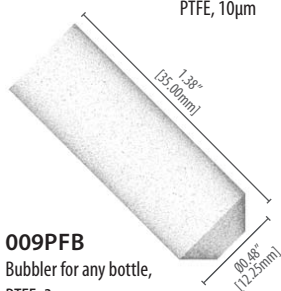

**009PFB**  
Bubbler for any bottle,  
PTFE, 3µm

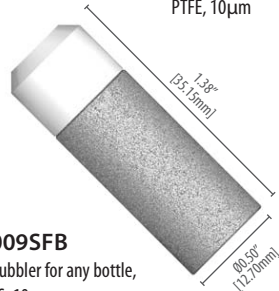

**009SFB**  
Bubbler for any bottle,  
SS, 10µm

### Ordering information

#### BOTTOM-OF-BOTTLE FILTERS

| PART NUMBER | DESCRIPTION                                     | QTY  |
|-------------|---|------|
| 009F-32     | Bottom-of-bottle filter for GL32 /38-430 bottle | ea   |
| 009F-45     | Bottom-of-bottle filter for GL45 bottle         | ea   |
| 009FE-32    | Replacement filters for 009F-32                 | 20pk |
| 009FE-45    | Replacement filters for 009F-45                 | 20pk |

#### FILTER BUBBLERS

|        |                                |    |
|--------|--------------------------------|----|
| 009PFB | PTFE filter bubbler            | ea |
| 009SFB | Stainless steel filter bubbler | ea |

## BUBBLE TRAP

### Effective, in-line removal of bubbles

- Pressure rated up to 30 psi
- Effective de-bubbling of aqueous solutions

The Omnifit® Bubble Trap effectively removes bubbles\* from aqueous solutions. The unit is quickly and easily connected in-line using the 1/4"-28 UNF female threaded ports and fittings such as Omni-Lok™. Spare membranes are available.

\* Note: the bubble trap does not remove dissolved gases

### SPECIFICATIONS

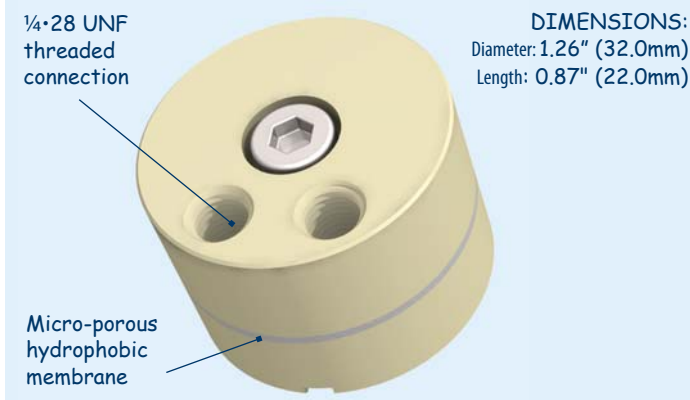

### Operation

When a fluid containing bubbles flows through the unit, aqueous fluid is retained while bubbles are forced through a micro-porous, hydrophobic membrane. Because the membrane function depends on its hydrophobicity, the Trap is only suitable for use with aqueous systems and NOT with organic solvents.

### Flow

Maximum flow rate depends on the amount of bubbles in the liquid. Typical operating range is 0.5 - 2.0ml/min, but up to 6ml/min can be achieved if few bubbles are present in the liquid.

### Pressure

The unit is pressure rated up to 30psi. De-bubbling is effected under positive pressure. It is not possible to pull liquid through the unit under vacuum as this would introduce bubbles into the fluid. If the system back-pressure is insufficient for the unit to function, a length of tube can be fitted on the outlet side to create more back-pressure.

### Maintenance

Membrane lifetime strongly depends on the kind of fluid being used. For pure water, the lifetime may be several months or years. Buffer solutions reduce lifetime and it is advisable to flush the unit with de-ionized/distilled water after use to prevent salt crystals forming.

#### INLINE BUBBLE TRAP

| PART NUMBER | FILTER MATERIAL | CONNECTION 1 | CONNECTION 2 | QTY |
|-------------|-----------------|--------------|--------------|-----|
| 006BT       | PTFE            | 1/4-28       | 1/4-28       | ea  |

#### REPLACEMENT FILTER ELEMENTS

| PART NUMBER | FILTER MATERIAL | QTY |
|-------------|-----------------|-----|
| 006BTF      | PTFE            | ea  |

## PRESSURE RATED GLASS BOTTLES

### Clear 1L glass bottles pressure rated to -1 / + 1.5 bar

- 1L GL45 thread bottles suitable for pressurised applications
- Indelible volumetric markings
- Chemically-resistant borosilicate glass

Bottles are pressure rated to -1 / +1.5 bar, so suitable for either vacuum or positive pressure applications.



### Ordering information

| GLASS BOTTLES |               |        |     |
|---------------|---------------|--------|-----|
| PART NUMBER   | BOTTLE THREAD | VOLUME | QTY |
| 003406        | GL45          | 1L     | ea  |

**CAUTION:** Only bottles specified as pressure rated are recommended for pressure or vacuum delivery of liquids. Always treat glass bottles with care.

## S40 THREAD ADAPTOR

### Convert S40 bottle threads to accept any Omnifit® GL45 bottle caps from the T- and Q-series

- Fits any S40 threaded bottle
- Accepts any GL45 threaded Q or T-series bottle cap

The S40 thread adaptor provides a simple way to use any Omnifit® GL45 thread cap with S40 thread glass or plastic bottles. Simply screw the adaptor onto the bottle neck to make a GL45 thread connection.

### Materials

The S40 thread adaptor is constructed from solid PTFE providing the highest chemical inertness. The PTFE creates a reliable seal to the glass bottle with no need for extra seals or O-rings.

### Dimensions

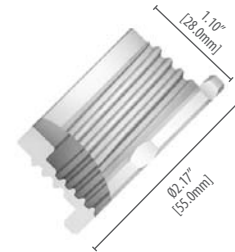

### Assembly

Screw the S40 adaptor onto the bottle neck first. Screw any GL45 cap from the Q or T-series onto the adaptor.



### Ordering information

| S40 to GL45 THREAD ADAPTOR |               |            |     |
|----------------------------|---------------|------------|-----|
| PART NUMBER                | BOTTLE THREAD | CAP THREAD | QTY |
| 00945A-S40                 | S40           | GL45       | ea  |

## CLOSED SYSTEMS FOR SOLVENT SAFETY

Open solvent bottles can allow harmful solvent vapor to escape and chemicals to be spilled. Omnifit® bottle caps and accessories help prevent these problems and give you the security of a safe and dependable solvent delivery system. Caps can be used on the supply side to provide closed delivery systems for safe supply of solvents. An optional check valve and filter enables pressure equalization and prevents contamination. Caps can also be used for safe disposal of solvent waste, providing a closed waste system.

## What are the benefits of a closed system?

- **Safety** - closed solvent supply systems prevent vapor leakage into the atmosphere, protecting lab staff from exposure to toxic fumes.
- **Contamination control** - prevents ingress of particulates.
- **Protection of mixing ratios** - prevent evaporation of solvent leading to altered concentration of reagents or ratios of mixtures.

## Where should you use a closed system?

- **HPLC** - mobile phase handling, both solvent supply and waste collections.
- **Fermentation or culture preparations** - where sterile transfer of culture media or addition of reagents to closed systems is required.
- **All labs working with solvents, reagent supply and waste handling** - where safety and contamination control are paramount in life sciences, analytical chemistry, clinical, and biotech.

## What are the key differences between the Omnifit® bottle cap ranges?

## Q-series with ¼"-28 UNF threaded ports

- Optional valves offer easy on-off control of individual fluid lines, ideal for selecting flow or for closing off lines prior to removing caps to change or re-fill solvent bottles.
- Robust threaded ports for standard ¼"-28 UNF threaded fitting nuts and adaptors gives a secure connection ideal for repeated connect / disconnect.
- Optional screw-in check valve and filter accessory enables pressure equalization while keeping the system closed and preventing both particulate contamination and evaporation of expensive or harmful chemicals.

## T-series with Luer ports

- Simple and easy-to-use with no need for fitting nuts and ferrules (for ⅜" OD semi-rigid tube). Tubing passes straight through the cap for a continuous fluid path.
- Luer ports take standard male Luer components including a range of accessories for different tubing types and sizes.
- Optional integrated check valve and filter enables pressure equalization whilst keeping the system closed and preventing particulate contamination or evaporation of expensive or harmful chemicals.
- A Luer connection solvent vapor trap can be used to contain / control vapor egress into the environment.

## WASTE-SIDE SOLVENT SAFETY

Both the Q and T-series caps can be used for waste collection vessels. Because waste systems require positive pressure to be applied in pumping waste solvent into the bottle, certain accessories are needed to convert "standard" Omnifit® bottle caps to waste collection.

## Q-series

Any Q-series cap can be used for waste collection with the following changes:

- An outlet version screw-in check valve and filter (Part # 009VF-W) must be used in one of the ports. This allows air to escape from the bottle as liquid is pumped in , preventing pressure build-up.
- In order to control vapor in the environment released via the check valve, precautions for vapor containment should be made, such as placing the system in a fume hood.

## T-series

Any T-series cap can be used for waste collection with the following changes:

- A solvent trap (Part # 009CF-T) should be push-fitted into a spare Luer port. As liquid is pumped into the bottle, vapor can pass out through the trap, equalizing pressure. Dangerous solvent vapor is neutralized by the activated carbon contained in the unit.
- Any other unused ports must be sealed using a Luer plug (part # 009LP) to prevent solvent vapor escaping directly into the environment. Note: The push-fit nature of the vapor trap and Luer plugs mean that only low positive pressure should be applied to prevent Luer connections being loosened.

## ANTI-TWIST DESIGN

All Omnifit® bottle caps have this anti-twist feature, allowing the body to spin freely within the cap. The benefit of this design is that tubes no longer get twisted when the cap is fitted or removed from the bottle and there is no need to disconnect fluid lines before unscrewing the cap.

The inner body of each Omnifit® cap is made from PTFE, providing the highest chemical inertness. PTFE also creates a reliable seal to the glass bottle with no need for extra seals or O-rings.

Outer PP cap is not in contact with the fluid path in normal use

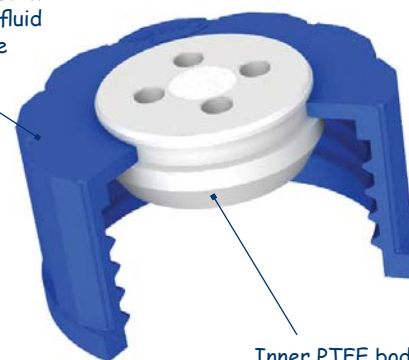

Inner PTFE body rotates within the cap



## INERT FLUID HANDLING COMPONENTS AND LABWARE

Omnifit® fittings, bottle-caps, chromatography columns and broad assortment of connectors and adaptors distinguish themselves by their versatility, ease-of-use and chemical resistance. Since 1973, these products enjoy worldwide renown throughout the scientific research community.

Omnifit® products are employed as critical components by instrument manufacturers serving a host of analytical and industrial applications including:

- Chromatography
- Chemical research
- Biotechnology
- Hematology and other in-vitro analysis
- Pharmaceutical analytical research
- Industrial quality testing
- Printing
- Water / environmental monitoring

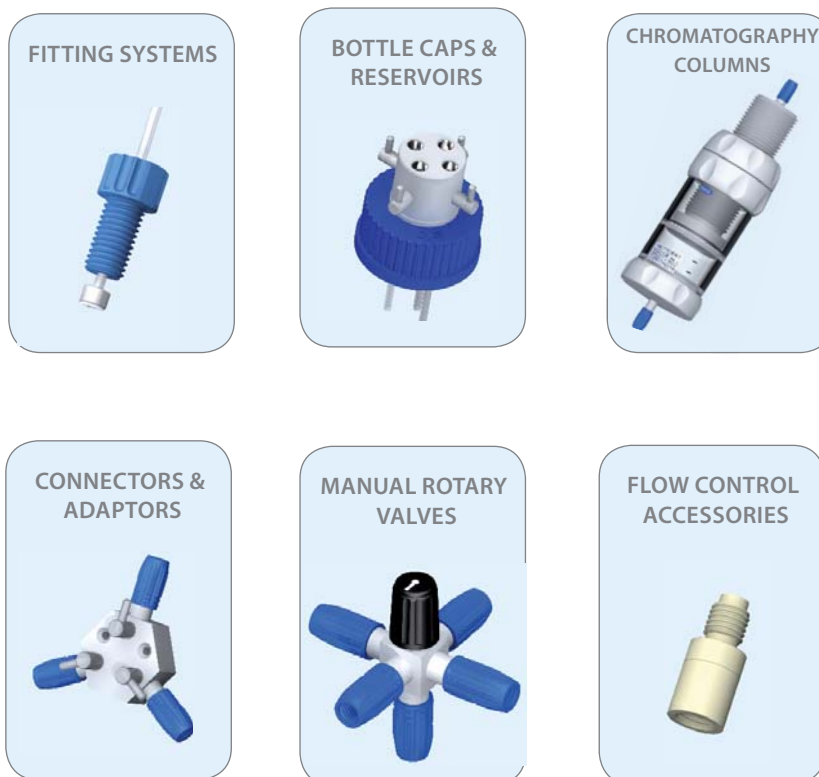

... the standard in fluid handling



[www.dibaind.com](http://www.dibaind.com)

Diba Industries Inc  
4 Precision Road, Danbury CT 06810 USA  
t: (203) 744 0773 f: (203) 744 0525 e: [sales@dibaind.com](mailto:sales@dibaind.com)

Diba Industries Ltd  
2 College Park, Coldhams Lane, Cambridge CB1 3HD UK  
t: +44 (0) 1223 472801 f: +44 (0) 1223 416787 e: [sales@dibaind.com](mailto:sales@dibaind.com)

Registered in England No. 1138135 VAT Registration No. GB 214 4798 56